



**Pb Free**

# Specification

## UR101

SSC		Customer
Drawn	Approval	Approval

# [ Contents ]

- 1. Description**
- 2. Absolute maximum ratings**
- 3. Electro-Optical characteristics**
- 4. Characteristic diagrams**
- 5. Reliability result**
- 6. Rank**
- 7. Outline Dimension**
- 8. Material**
- 9. Reel Structure**
- 10. Packing**
- 11. Soldering profile**
- 12. Precaution for Use**

# UR101

## 1. Description

- Small size suitable for compact appliances.
- Surface-mounted chip LED device.
- Pb-free and RoHS complaint component.
- High brightness, High efficiency
- Tape and Reel packing.
- Increases the life time of battery.



## UR101

## Features

- 1.6 X 0.8 X 0.8 mm
- Untinted, Diffused flat mold
- Peak Wavelength : 660nm

## Applications

- ◆ Cellular phone's keypad lightning
- ◆ Information Boards

## 2. Absolute maximum ratings

(Ta=25℃)

Parameter	Symbol	Value	Unit
Power Dissipation	$P_d$	61.5	mW
Forward Current	$I_F$	30	mA
Peak Forward Current	$I_{FM}^{*1}$	100	mA
Reverse Voltage	$V_R$	5	V
Operating Temperature	$T_{opr.}$	-40 ~ 85	℃
Storage Temperature	$T_{stg.}$	-40 ~ 100	℃

\*1  $I_{FM}$  conditions: Pulse width  $T_w \leq 1\text{msec}$  and Duty ratio  $\leq 1/10$ .

## 3. Electro-Optical Characteristics

(Ta=25℃)

Parameter	Symbol	Condition	Min	Typ	Max	Unit
Forward Voltage	$V_F$	$I_F=20\text{mA}$	1.7	1.9	2.05	V
Reverse Current	$I_R$	$V_R=5\text{V}$	-	-	10	uA
Luminous Intensity*2	$I_V$	$I_F=20\text{mA}$	45	85	125	mcd
Wavelength	$\lambda_p$	$I_F=20\text{mA}$	650	660	668	nm
Spectral Bandwidth	$\Delta\lambda$	$I_F=20\text{mA}$	-	20	-	nm
Viewing Angle*3 (Y)	$2\theta_{1/2}$	$I_F=20\text{mA}$	-	156	-	°

\*2 The luminous intensity  $I_V$  is measured at the peak of the spatial pattern which may not be aligned with the mechanical axis of the LED package.

\*3  $\theta_{1/2}$  is the off-axis where the luminous intensity is 1/2 the peak intensity.

[Note] All measurements were made under the standardized environment of SSC.

(Tolerance :  $I_V \pm 10\%$ ,  $\lambda_d \pm 2\text{nm}$ ,  $V_F \pm 0.1\text{V}$ )

### 4. Characteristic Diagrams

Ta = 25°

**Forward Current vs. Forward Voltage**

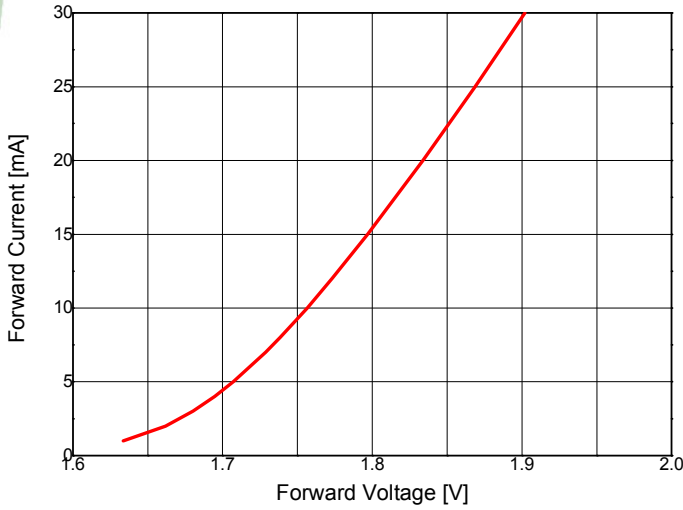

**Relative Luminous Intensity vs. Forward Current**

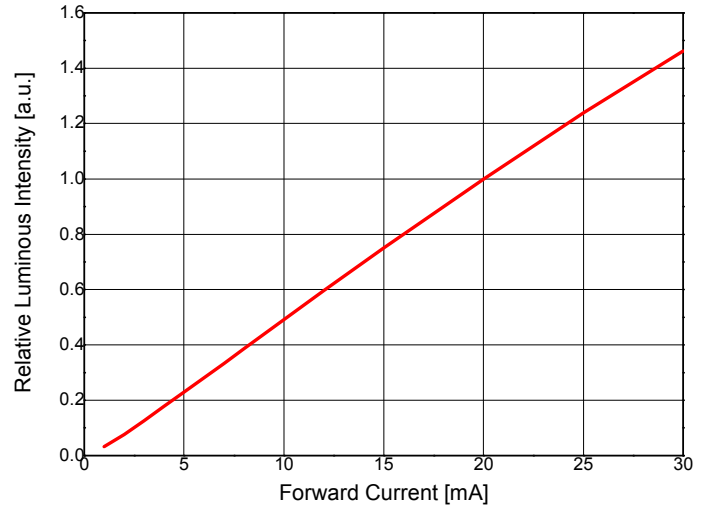

**Forward Current vs. Ambient Temperature**

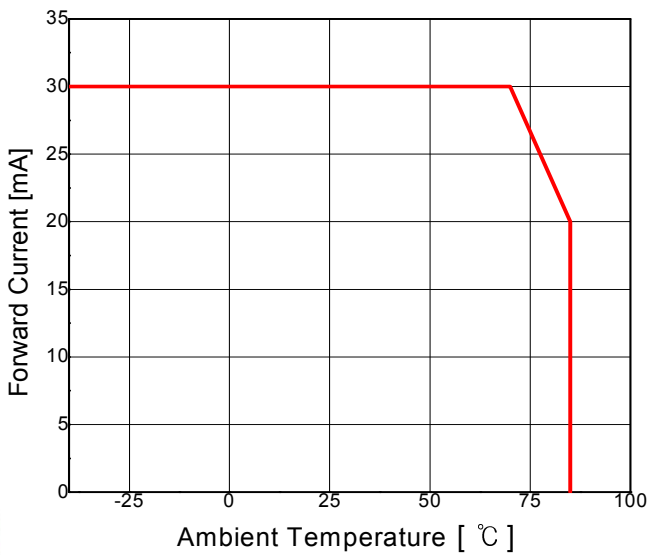

**Spectrum**

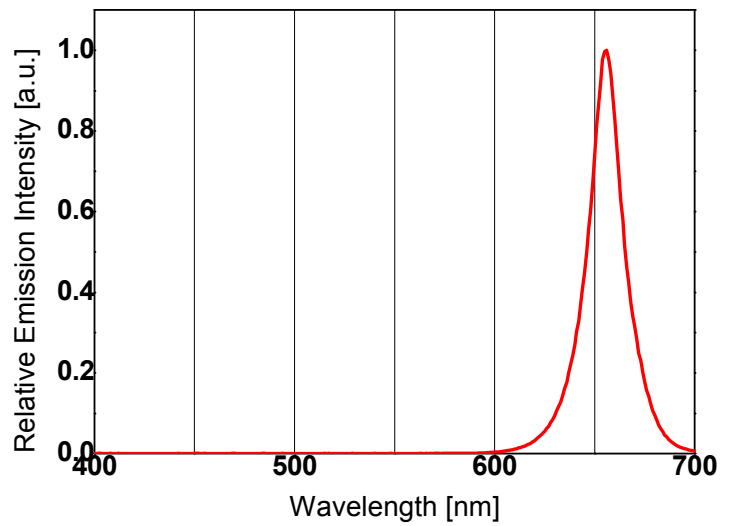

Radiation Diagram

Ta = 25°

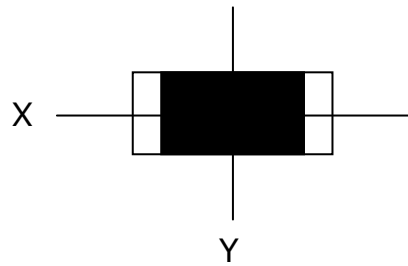
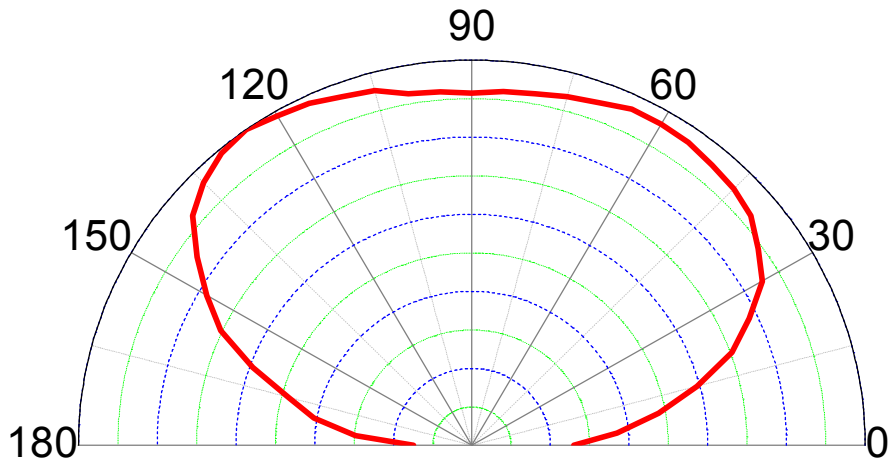

### 5. Reliability Test

Item	Test Conditions	Duration / Cycle	Number Of Damaged
Operating at Room temperature	20mA, @25°C	500 hrs	0/22
Operating at High temperature	20mA, @85°C	500 hrs	0/22
Operating at High temperature / High humidity	20mA, @60°C,90%	500 hrs	0/22
Thermal shock test	-40~85°C Shift (2hr/cycle)	100 cycle	0/22
Thermal resistance Test	85°C, 85% 24hrs → Reflow 3 times (Max 260°C 10sec) → Thermal shock 30 cycle	1 time	0/22

MSL : 2a (30°C, 60% : 4 weeks)

\*Criterion

	OK
I <sub>v</sub>	> Initial value * 0.5
V <sub>F</sub>	Initial value ± 0.1V

**6. Rank**

**$I_F = 20\text{mA}$**

<b>BIN</b>	<b><math>I_V</math> [mcd]</b>	<b><math>V_F</math> [V]</b>	<b><math>W_P</math> [nm]</b>
<b>A</b>	45-85	1.7-2.05	650-668
<b>B</b>	85-125	1.7-2.05	650-668



## 7. Outline Dimension

Tolerance  $\pm 0.1$ , Unit : mm

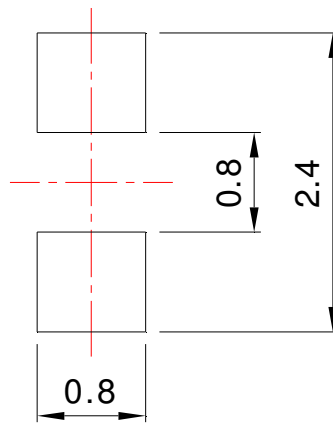
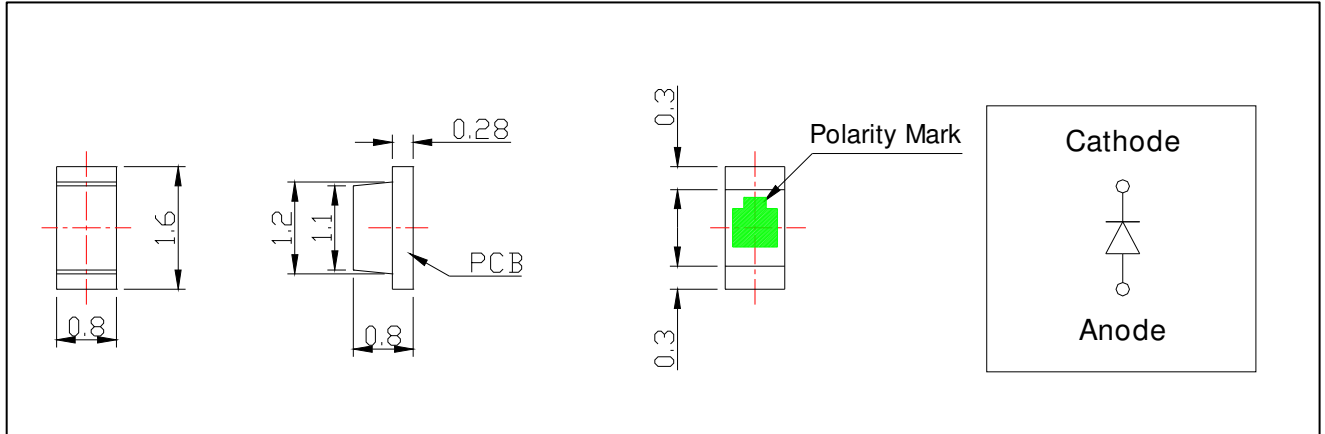

[Recommended Solder Pattern]

## 8. Material

Item	Substrate	chip	wire	Encapsulate	Electrode
Material	BT-Resin PCB	AlGaAs	Gold	Epoxy	Au Plated

### 9. Reel Structure

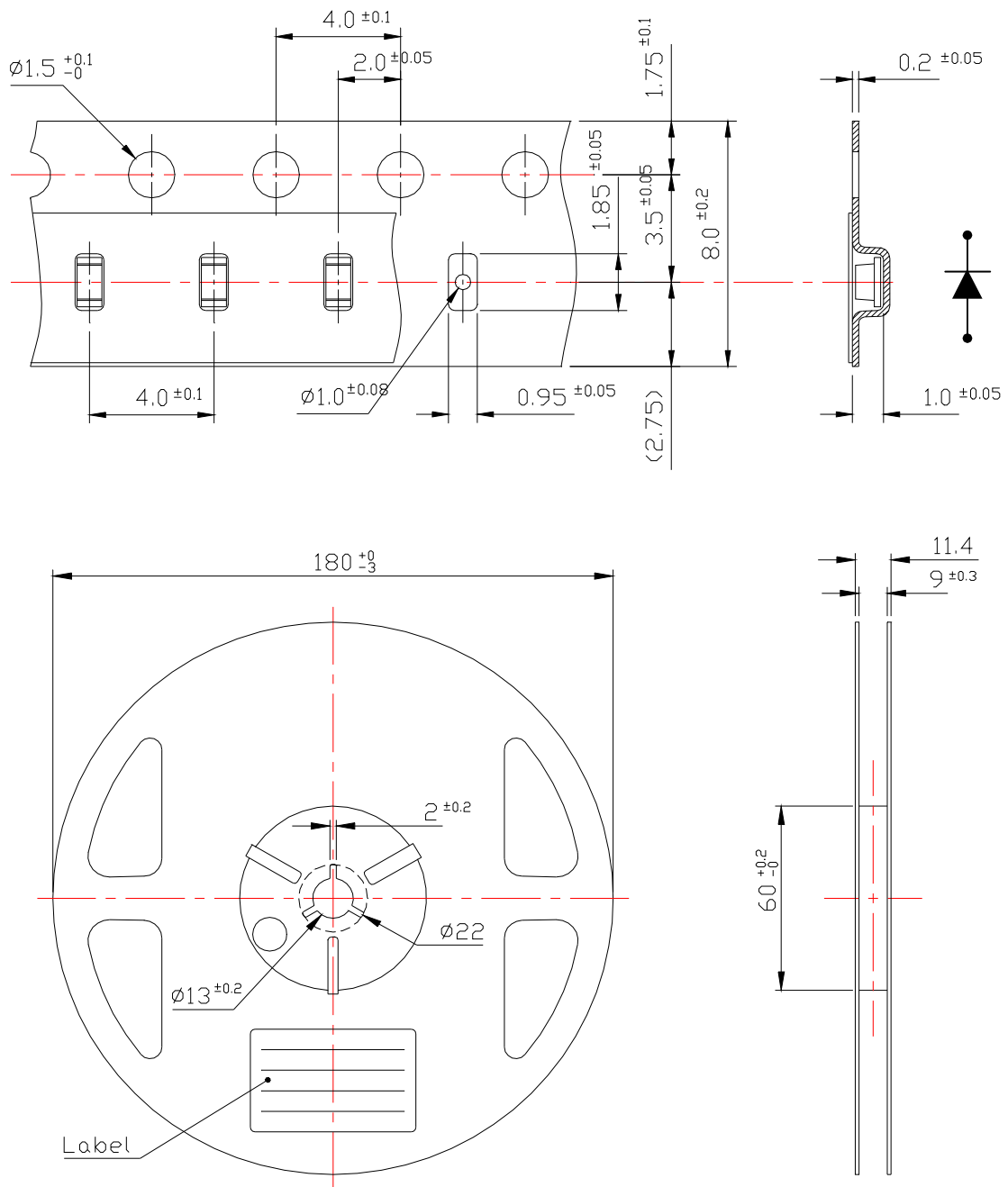

- (1) Quantity : 4000pcs/Reel
- (2) Cumulative Tolerance : Cumulative Tolerance/10 pitches to be  $\pm 0.2$ mm
- (3) Adhesion Strength of Cover Tape : Adhesion strength to be 0.1-0.7N when the cover tape is turned off from the carrier tape at  $10^\circ\text{C}$  angle to be the carrier tape
- (4) Package : P/N, Manufacturing data Code No. and quantity to be indicated on a damp proof Package

### 10. Packing

#### Reel

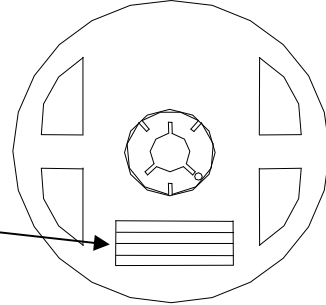
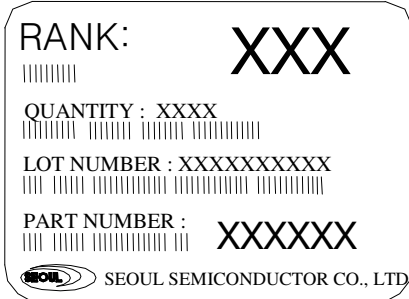

#### Aluminum Vinyl Bag

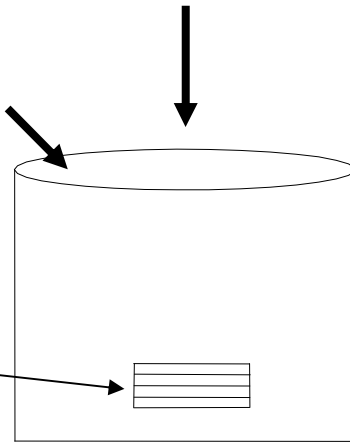
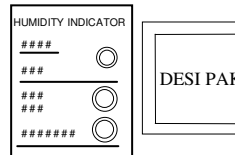
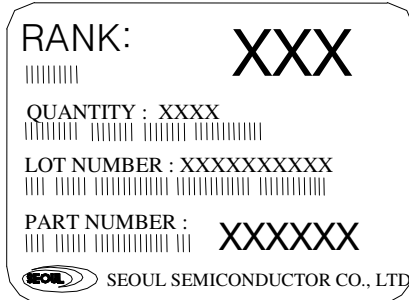

#### Outer Box Structure

① SIDE

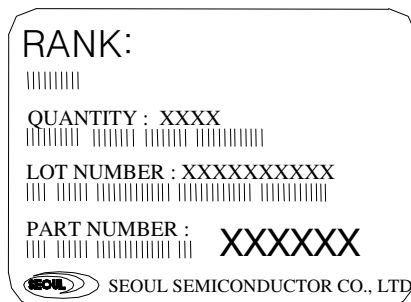

② SIDE

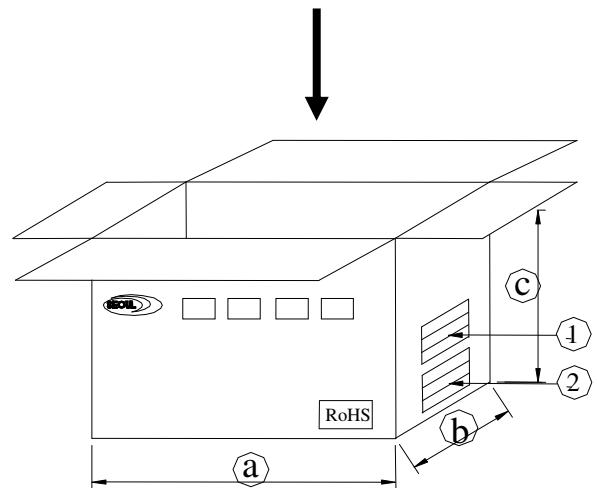
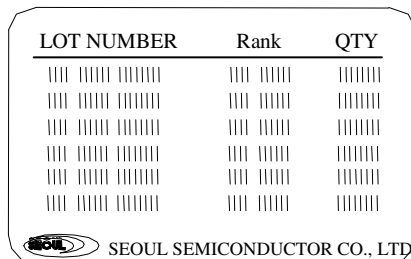

Material : Paper(SW3B(B))

TYPE	SIZE (mm)		
	a	b	c
7inch	245	220	142

## 11. Soldering profile

### (1) Lead Solder

Lead Solder	
Pre-heat	120~150℃
Pre-heat time	120 sec. Max.
Peak-Temperature	240℃ Max.
Soldering time Condition	10 sec. Max.

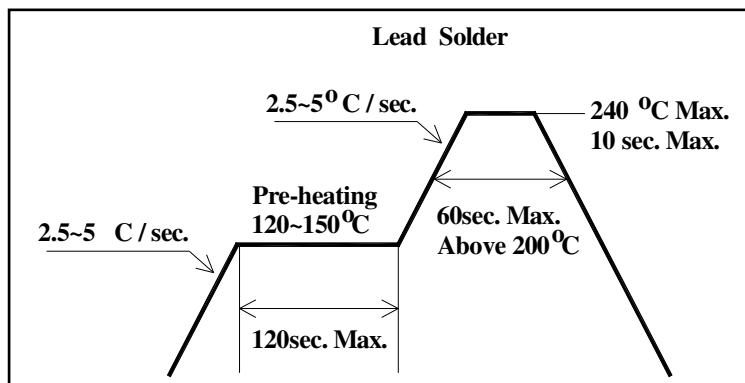

### (2) Lead-Free Solder

Lead Free Solder	
Pre-heat	150~200℃
Pre-heat time	120 sec. Max.
Peak-Temperature	260℃ Max.
Soldering time Condition	10 sec. Max.

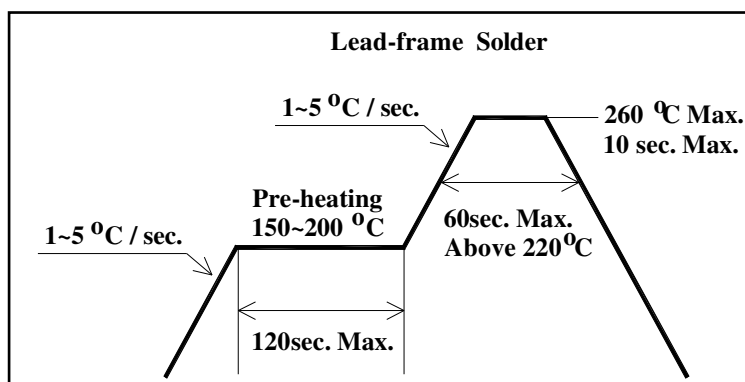

### (3) Hand Soldering conditions

**Do not exceed 3 seconds at maximum 280°C under soldering iron.**

Note : In case that the soldered products are reused in soldering process, we don't guarantee the products.

## 12. Precaution for Use

### (1) Storage

LEDs must be stored at clean atmosphere. If the LEDs are stored for 3 months or more after shipment from SSC, storage in a sealed container with a nitrogen atmosphere is recommended. To avoid absorption of moisture, it is recommended to store in a dry box (or a desiccator) with a desiccant.

\* Shelf Life : 12 months at < 40°C and 90%RH

### (2) Attention after open.

LED is correspond to SMD, when LED be soldered dip, interfacial separation may affect the light transmission efficiency, causing the light intensity to drop. After opened and mounted the soldering shall be quickly.

\* Within 672 hours at factory conditions of equal to or less than 30°C/60%RH, or  
Stored at < 10% RH

(3) Repack unused products with anti-moisture packing, fold to close any opening and then store in a dry place.

(4) In the case of change color of indicator on desiccant, components shall be dried 10-12hr at 60± 5°C.

(5) When the LED is operating, the driving current should be determined after considering the maximum ambient temperature requirements.

(6) When using multiple LEDs, It is recommended to connect a resistor on each LED. Otherwise, LEDs may vary due to variation in forward voltage of the LEDs.

(7) The driving circuit must be designed to allow forward voltage only when it is ON or OFF. If the reverse voltage is applied to LED, migration can be generated resulting in LED damage

(8) Any mechanical force or excessive vibration should be avoided during temperature cooling process to normal temperature after reflow.

(9) Rapid cooling shall be avoided.

(10) LED should not be placed on a flexible area on the PCB.

(11) This device should not be used in any type of fluid such as water, oil, organic solvent etc. When washing is required, IPA should be used.

(12) Anti radioactive ray design is not considered for the products.

(13) Damage prevention from ESD or Surge.

It is highly recommended to use the wrist-band or anti electrostatic gloves when handling the LED's All devices, equipments and machines must be properly grounded

(14) The appearance and specifications of the product may be modified for improvement without notice.