

40V N-ch Power MOSFET

General Features

- Proprietary New Trench Technology
- $R_{DS(ON),typ.} = 1.8m\Omega @ V_{GS}=10V$
- Low Gate Charge Minimize Switching Loss
- Fast Recovery Body Diode

BV_{DSS}	$R_{DS(ON),max.}$	$I_D^{[2]}$
40V	2.0m Ω	262A

Applications

- High efficiency DC/DC Converters
- Synchronous Rectification
- UPS Inverter

Ordering Information

Part Number	Package	Marking
MXP4002AT	TO-220	MXP4002AT

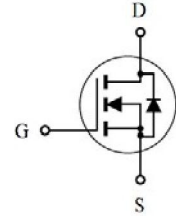
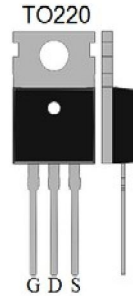

Absolute Maximum Ratings

$T_C=25^\circ C$ unless otherwise specified

Symbol	Parameter	Value	Unit
V_{DSS}	Drain-to-Source Voltage ^[1]	40	V
V_{GSS}	Gate-to-Source Voltage	± 20	
I_D	Continuous Drain Current ^[2]	262	A
	Continuous Drain Current ^[3]	192	
	Continuous Drain Current at $T_C=100^\circ C$ ^[2]	185	
I_{DM}	Pulsed Drain Current at $V_{GS}=10V$ ^[2,4]	1047	
E_{AS}	Single Pulse Avalanche Energy ($V_{DD}=30V, V_{GS}=10V, R_G=25\Omega, L=1mH$)	685	mJ
P_D	Power Dissipation	253	W
	Derating Factor above $25^\circ C$	1.7	W/ $^\circ C$
T_L	Soldering Temperature	300	$^\circ C$
	Distance of 1.6mm from case for 10 seconds		
T_J & T_{STG}	Operating and Storage Temperature Range	-55 to 175	

Caution: Stresses greater than those listed in the "Absolute Maximum Ratings" may cause permanent damage to the device.

Thermal Characteristics

Symbol	Parameter	Min.	Typ.	Max.	Unit
$R_{\theta JC}$	Thermal Resistance, Junction-to-Case			0.59	$^\circ C/W$
$R_{\theta JA}$	Thermal Resistance, Junction-to-Ambient			62	

Electrical Characteristics

OFF Characteristics

 $T_J = 25^\circ\text{C}$ unless otherwise specified

Symbol	Parameter	Min.	Typ.	Max.	Unit	Test Conditions
BV_{DSS}	Drain-to-Source Breakdown Voltage	40			V	$V_{GS}=0V, I_D=250\mu A$
I_{DSS}	Drain-to-Source Leakage Current			1	μA	$V_{DS}=32V, V_{GS}=0V$
I_{GSS}	Gate-to-Source Leakage Current			± 100	nA	$V_{GS}=\pm 20V, V_{DS}=0V$

ON Characteristics

 $T_J = 25^\circ\text{C}$ unless otherwise specified

Symbol	Parameter	Min.	Typ.	Max.	Unit	Test Conditions
$R_{DS(ON)}$	Static Drain-to-Source On-Resistance	--	1.7	2.0	m Ω	$V_{GS}=10V, I_D=192A^{[5]}$
$V_{GS(TH)}$	Gate Threshold Voltage	2.0	--	4.0	V	$V_{DS} = V_{GS}, I_D=250\mu A$

Dynamic Characteristics

Essentially independent of operating temperature

Symbol	Parameter	Min.	Typ.	Max.	Unit	Test Conditions
C_{iss}	Input Capacitance		7.7		nF	$V_{GS}=0V, V_{DS}=25V, f=1.0MHz$
C_{rss}	Reverse Transfer Capacitance		0.25			
C_{oss}	Output Capacitance		1.2			
R_g	Gate Series Resistance		2.7		Ω	$f=1.0MHz$
Q_g	Total Gate Charge		124		nC	$V_{DD}=20V, I_D=120A, V_{GS}=10V$
Q_{gs}	Gate-to-Source Charge		40			
Q_{gd}	Gate-to-Drain (Miller) Charge		30			

Resistive Switching Characteristics

Essentially independent of operating temperature

Symbol	Parameter	Min.	Typ.	Max.	Unit	Test Conditions
$t_{d(on)}$	Turn-on Delay Time		27		ns	$V_{DD}=20V, I_D=120A, V_{GS}=10V, R_G=2.5\Omega$
t_{rise}	Rise Time		26			
$t_{d(off)}$	Turn-off Delay Time		80			
t_{fall}	Fall Time		19			

Source-Drain Body Diode Characteristics

 $T_J = 25^\circ\text{C}$ unless otherwise specified

Symbol	Parameter	Min.	Typ.	Max.	Unit	Test Conditions
I_{SD}	Continuous Source Current ^[2]			262	A	Maximum Ratings
I_{SM}	Pulsed Source Current at $V_{GS}=10V^{[2,4]}$			1047	A	Maximum Ratings
V_{SD}	Diode Forward Voltage		0.9	1.2	V	$I_S=120A, V_{GS}=0V$
t_{rr}	Reverse Recovery Time		59		ns	$V_{GS}=0V, I_F=20A, di/dt=100A/\mu s$
Q_{rr}	Reverse Recovery Charge		100		nC	

Note:

 [1] $T_J = +25^\circ\text{C}$ to $+175^\circ\text{C}$

[2] Silicon limited current only

[3] Package limited current

[4] Repetitive rating, pulse width limited by both maximum junction temperature.

 [5] Pulse width $\leq 380\mu s$; duty cycle $\leq 2\%$.

Typical Characteristics

Figure 1. Maximum Effective Thermal Impedance, Junction-to-Case

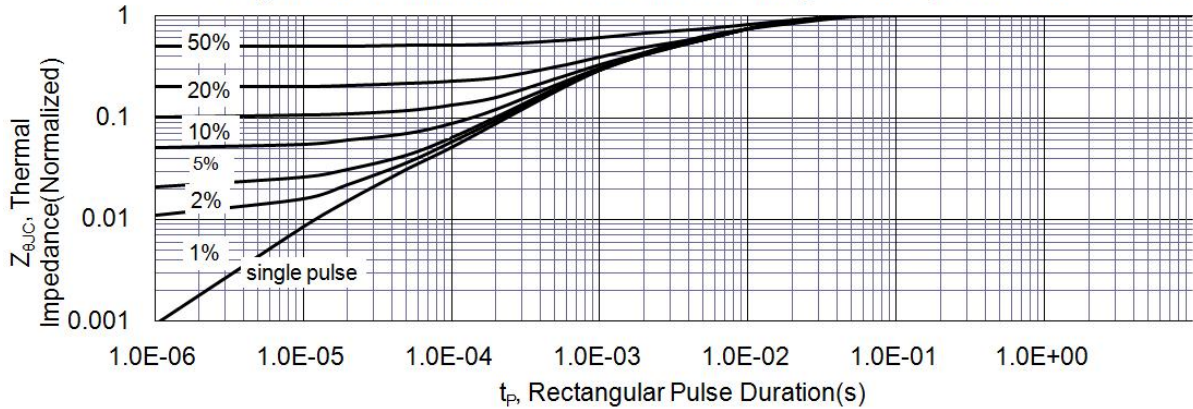

Figure 2. Maximum Power Dissipation vs. Case Temperature

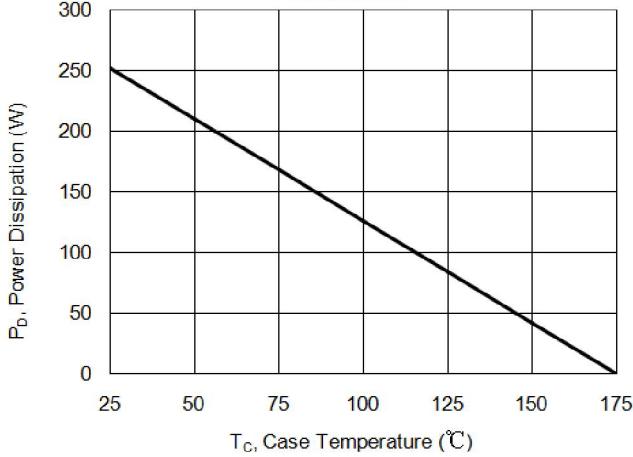

Figure 3. Maximum Continuous Drain Current vs Case Temperature

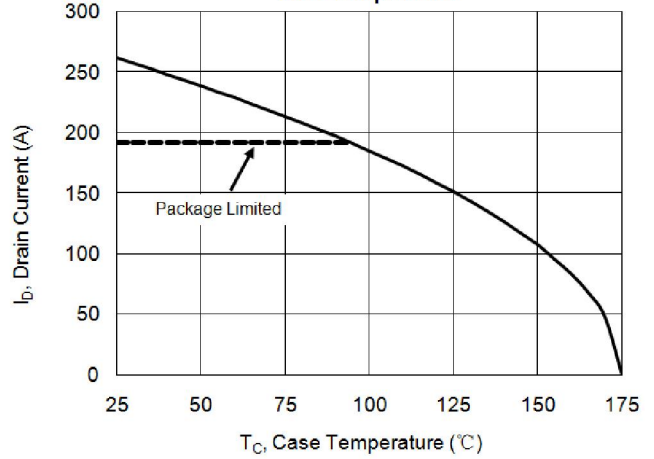

Figure 4. Typical Output Characteristics

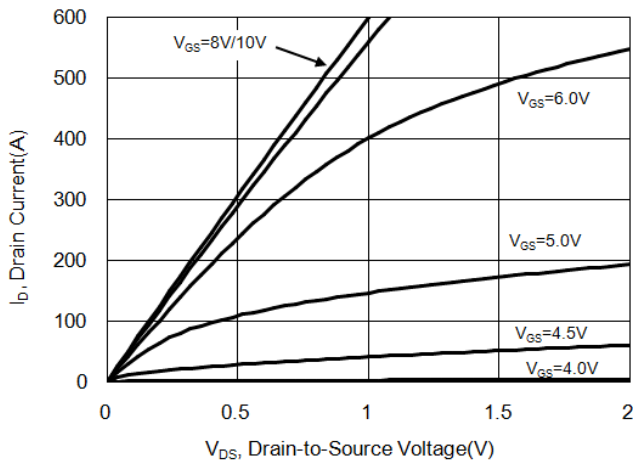

Figure 5. Typical Drain-to-Source ON Resistance vs. Gate Voltage

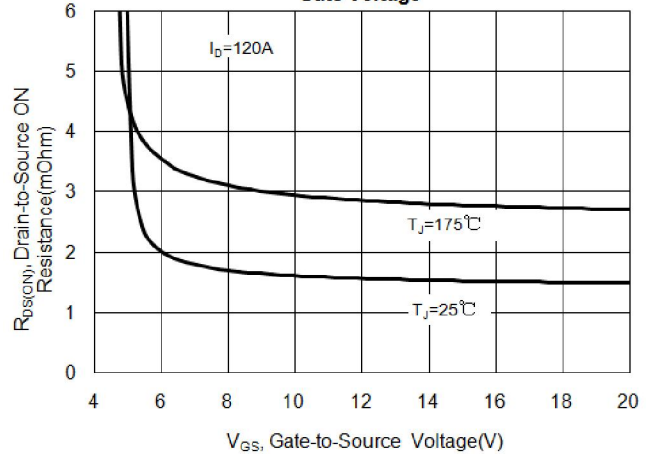

Figure 6. Maximum Peak Current Capability

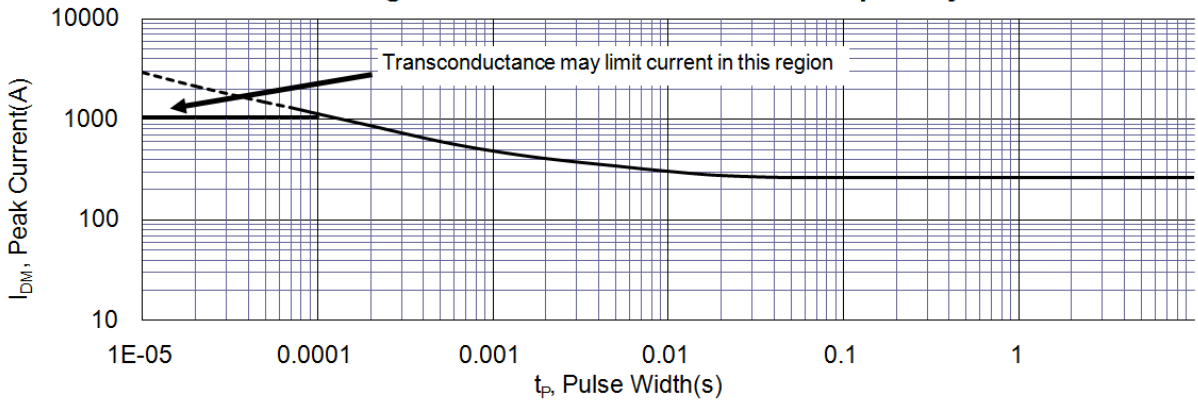

Figure 7. Typical Transfer Characteristics

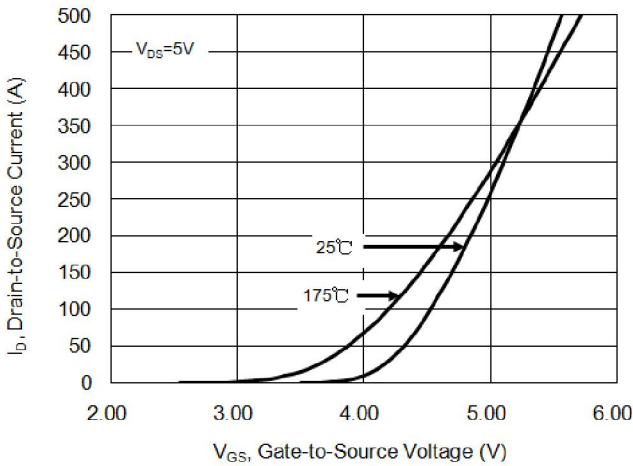

Figure 8. Unclamped Inductive Switching Capability

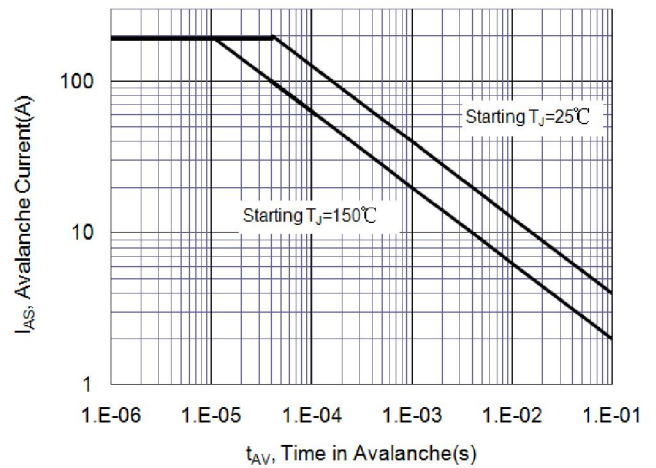

Figure 9. Typical Drain-to-Source ON Resistance

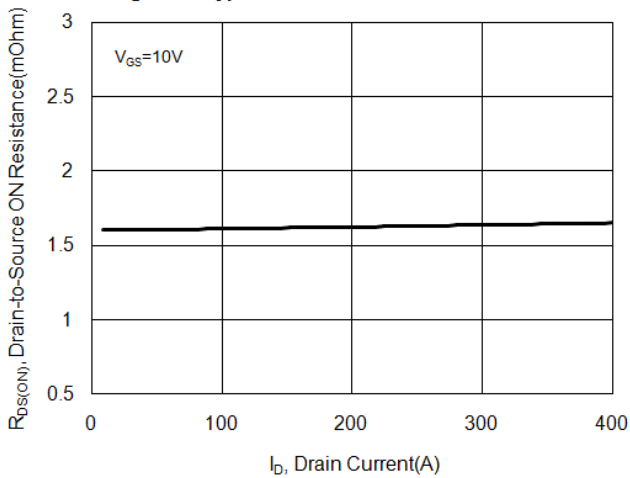

Figure 10. Typical Drain-to-Source On Resistance vs. Junction Temperature

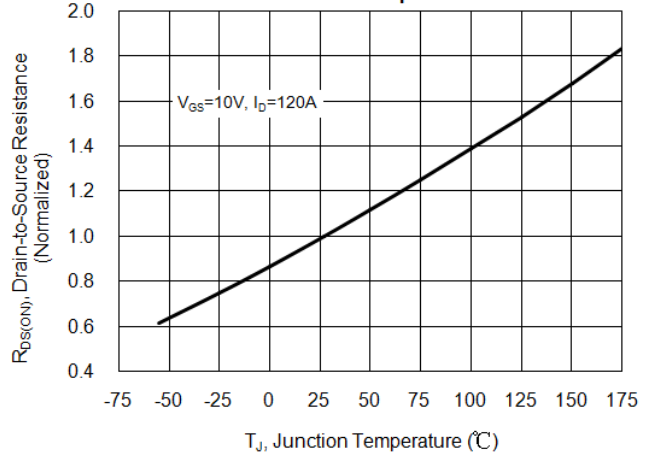

Figure 11. Typical Breakdown Voltage vs. Junction Temperature

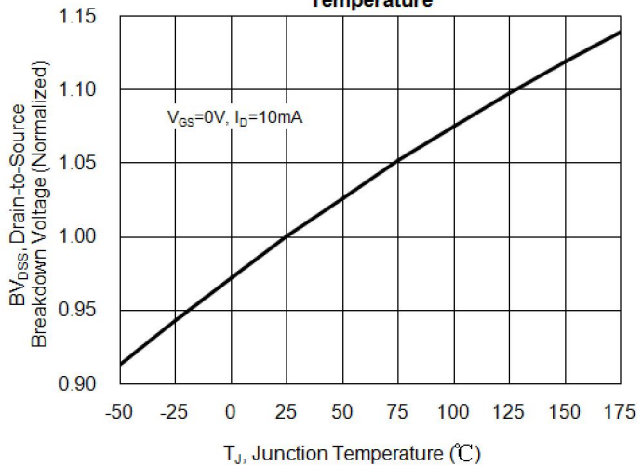

Figure 12. Typical Threshold Voltage vs. Junction Temperature

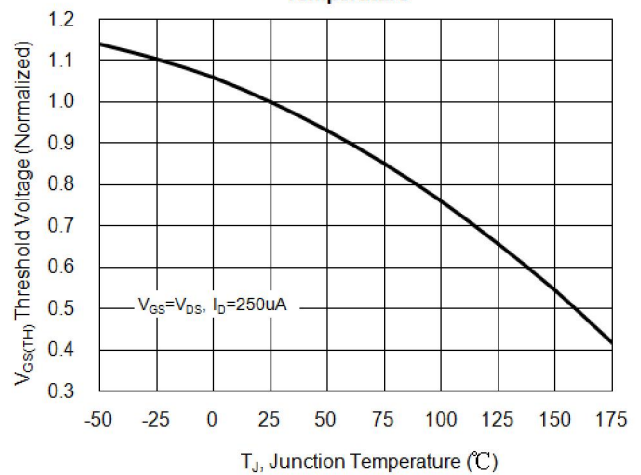

Figure 13. Maximum Forward Safe Operation Area

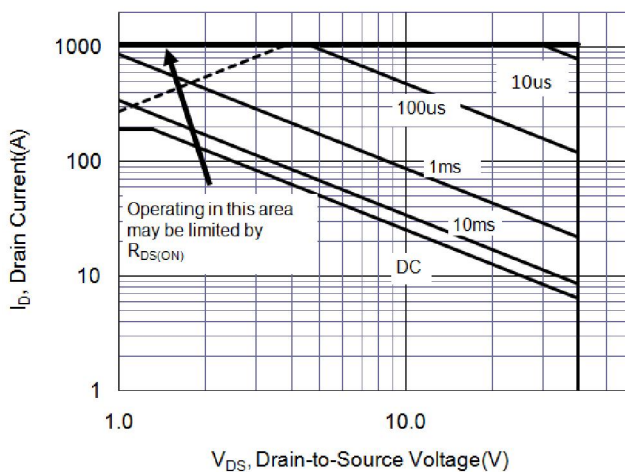

Figure 14. Typical Capacitance vs. Drain-to-Source Voltage

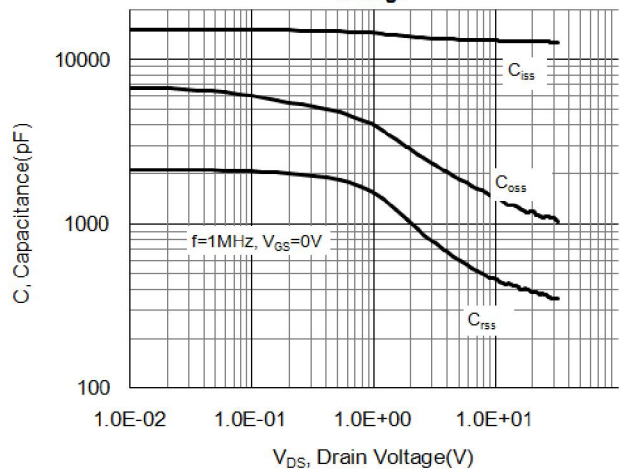

Figure 15. Typical Gate Charge vs. Gate-to-Source Voltage

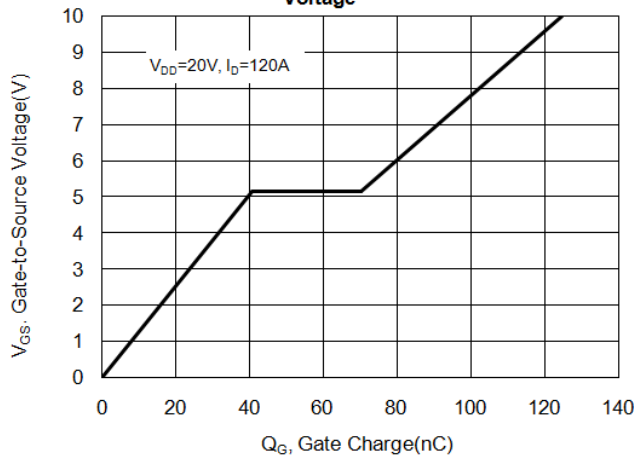
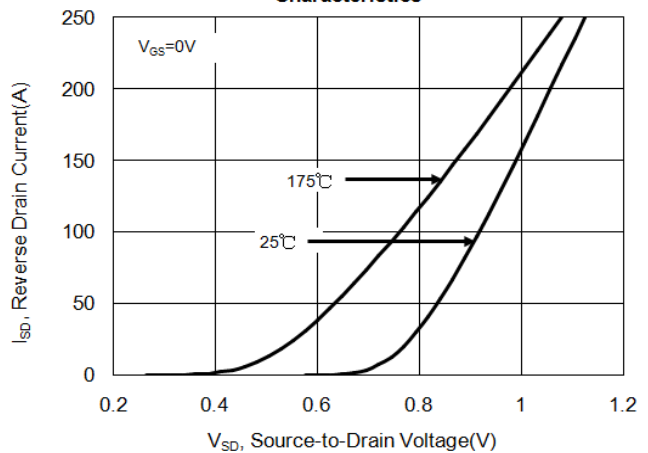
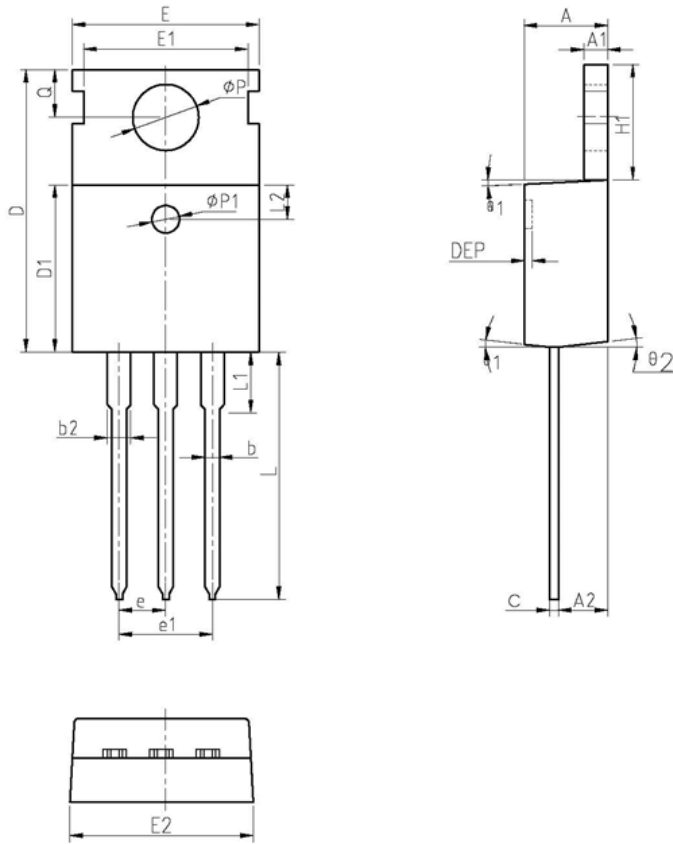

Figure 16. Typical Body Diode Transfer Characteristics



Package Dimensions

TO-220-3L



COMMON DIMENSIONS

SYMBOL	MIN	NOM	MAX	MIN	NOM	MAX
A	4.40	4.57	4.70	0.173	0.180	0.185
A1	1.27	1.30	1.33	0.050	0.051	0.052
A2	2.35	2.40	2.50	0.093	0.094	0.098
b	0.77	0.80	0.90	0.030	0.031	0.035
b2	1.17	1.27	1.36	0.046	0.050	0.054
c	0.48	0.50	0.56	0.019	0.020	0.022
D	15.40	15.60	15.80	0.606	0.614	0.622
D1	9.00	9.10	9.20	0.354	0.358	0.362
DEP	0.05	0.10	0.20	0.002	0.004	0.008
E	9.80	10.00	10.20	0.386	0.394	0.402
E1	-	8.70	-	-	0.343	-
E2	9.80	10.00	10.20	0.386	0.394	0.402
e	-	2.54	BSC	-	0.100	BSC
e1	-	5.08	BSC	-	0.200	BSC
H1	6.40	6.50	6.60	0.252	0.256	0.260
L	12.75	13.50	13.65	0.502	0.531	0.537
L1	-	3.10	3.30	-	0.122	0.130
L2	-	2.50	REF	-	0.096	REF
ΦP	3.50	3.60	3.63	0.138	0.142	0.143
$\Phi P1$	3.50	3.60	3.63	0.138	0.142	0.143
Q	2.73	2.80	2.87	0.107	0.110	0.113
$\theta 1$	5°	7°	9°	5°	7°	9°
$\theta 2$	1°	3°	5°	1°	3°	5°
$\theta 3$	1°	3°	5°	1°	3°	5°

Disclaimers:

MaxPower Semiconductor Inc. (MXP) reserves the right to make changes without notice in order to improve reliability, function or design and to discontinue any product or service without notice. Customers should obtain the latest relevant information before orders and should verify that such information is current and complete. All products are sold subject to MXP's terms and conditions supplied at the time of order acknowledgement.

MaxPower Semiconductor Inc., its affiliates, agents, and employees, and all persons acting on its or their behalf, disclaim any and all liability for any errors, inaccuracies or incompleteness contained herein or in any other disclosure relating to any product.

MaxPower Semiconductor Inc. disclaims any and all liability arising out of the use or application of any product described herein or of any information provided herein to the maximum extent permitted by law. The product specifications do not expand or otherwise modify MXP's terms and conditions of purchase, including but not limited to the warranty expressed therein, which apply to these products.

MaxPower Semiconductor Inc. warrants performance of its hardware products to the specifications at the time of sale, testing, reliability and quality control are used to the extent MXP deems necessary to support this warrantee. Except where agreed upon by contractual agreement, testing of all parameters of each product is not necessarily performed.

MaxPower Semiconductor Inc. does not assume any liability arising from the use of any product or circuit designs described herein. Customers are responsible for their products and applications using MXP's components. To minimize risk, customers must provide adequate design and operating safeguards.

MaxPower Semiconductor Inc. does not warrant or convey any license to any intellectual property rights either expressed or implied under its patent rights, nor the rights of others. Reproduction of information in MXP's data sheets or data books is permissible only if reproduction is without modification or alteration. Reproduction of this information with any alteration is an unfair and deceptive business practice.

MaxPower Semiconductor Inc. is not responsible or liable for such altered documentation. Resale of MXP's products with statements different from or beyond the parameters stated by MaxPower Semiconductor Inc. for that product or service voids all express or implied warranties for the associated MXP product or service and is an unfair and deceptive business practice.

MaxPower Semiconductor Inc. is not responsible or liable for any such statements.

Published by MaxPower Semiconductor Inc.
181 Metro Dr, Suite 590, San Jose, CA 95110

All Rights Reserved.